



Life is Precious.  
Be Safe.

Koopers Distribution Sdn Bhd

☎ 03-78324338

🌐 [www.koopers.co](http://www.koopers.co)

📘 [www.facebook.com/koopersmalaysia](https://www.facebook.com/koopersmalaysia)

✉ [sales@koopers.co](mailto:sales@koopers.co)

📍 8, Jalan Zuhal U5/178, Seksyen U5, Bandar Pinggiran Subang  
40150 Shah Alam, Selangor, Malaysia



Life is Precious.  
Be Safe.

**R129 SAFE** COLLECTION

**FLEX**

40-150cm

Birth to 12 yrs

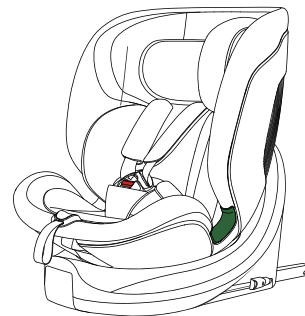

INSTRUCTION MANUAL

# STRUCTURE NAME

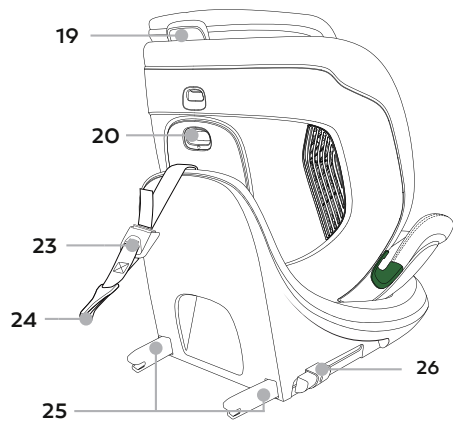
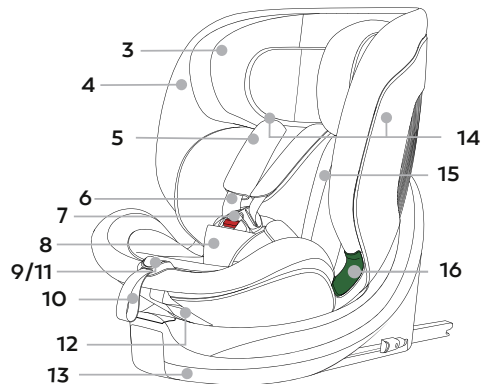

- 1 ISOFIX Insertion Aids(optional)
- 2 ISOFIX Fastening Points(vehicle)
- 3 Headrest
- 4 Seat Cover
- 5 Shoulder Pads
- 6 Shoulder Straps
- 7 Harness Buckle
- 8 Crotch Pad
- 9 Adjustment Button
- 10 Crotch Strap
- 11 360° Rotation Adjuster
- 12 Recline Handle
- 13 Base
- 14 Belt Guidance
- 15 Seat "Cradleyou" Reducer
- 16 Belt Guidance
- 17 Buckle Tongues
- 18 Red Release Button
- 19 Headrest Height Adjuster
- 20 Instruction Back Cover Button
- 21 Shoulder Belt Connector
- 22 Instruction Back Cover (can insert instruction into it)
- 23 Top Tether Adjuster
- 24 Top Tether Clip
- 25 ISOFIX Locking Arms
- 26 ISOFIX Buttons
- 27 R-elf

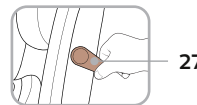
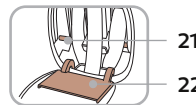
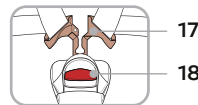
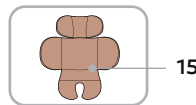
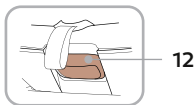
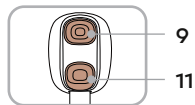
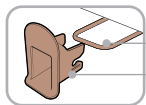

# INSTALLATION

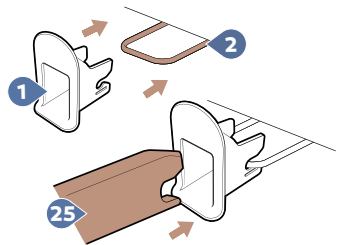

ISOFIX **1** **1**

Top Tether **2**

**3** Rotation

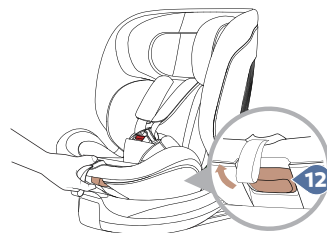
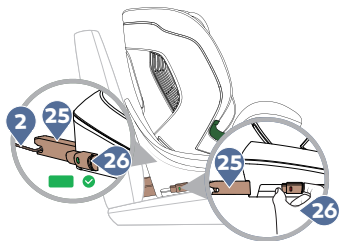

Seat Angle **4**

**5** Using

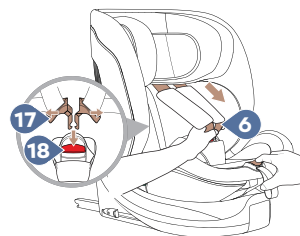

**6** Store 5-Point Harness

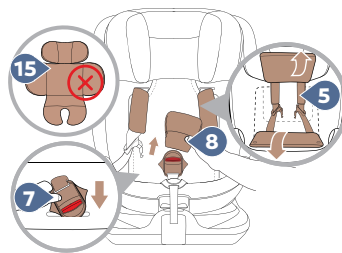
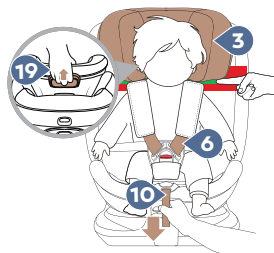
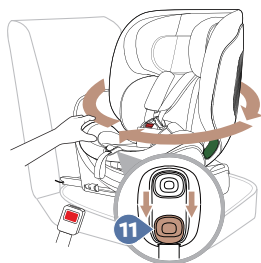
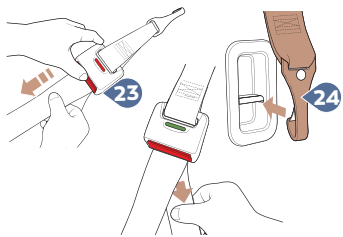

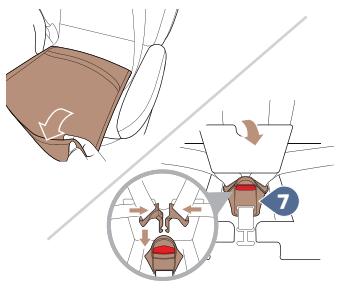

6

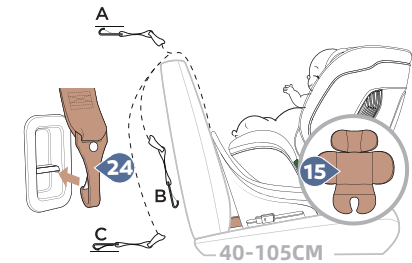

7

Using The Child Safety Seat

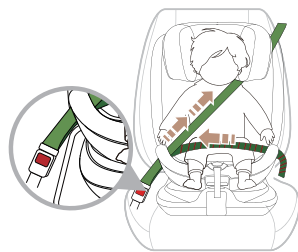

7

8 Clean

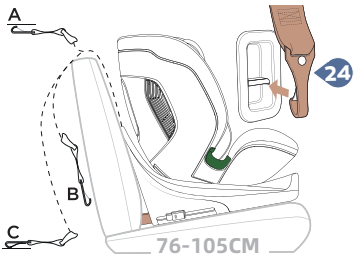
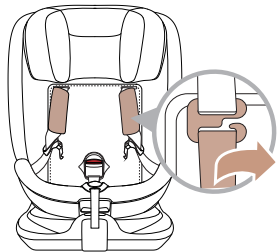

7

7

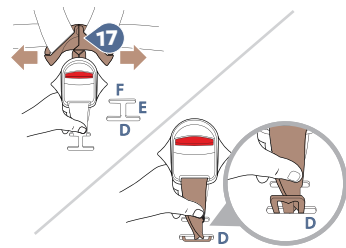
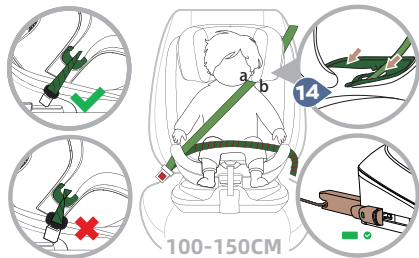

8

## APPROVAL

These instructions use the following symbols:

Symbol	Keyword	Explanation
	DANGER!	RISK of severe personal injury
	WARNING!	RISK of minor personal injury
	CAUTION!	RISK of material damage
	TIP!	Useful notes

The C007 i-Size is exclusively intended to secure your child in your vehicle.

Tested and approved according to ECE R129		
Body size	Installation method	Installation direction
40-105cm; ≤18kg	ISOFIX+Top Tether	Facing backwards
76-105cm; ≤18kg	ISOFIX+Top Tether	Facing forwards
100-150cm	Adult Safety-Belt+ISOFIX	
	Adult Safety-Belt only	

\*ECE=European Standard for Child Safety Equipment

The child safety seat has been designed, tested and approved according to the requirements of the European Standard for Child Safety Equipment (ECE R129/03).

The seal of approval "E" (in a circle) and the approval number are located on the orange approval label (sticker on the child safety seat).

**DANGER!** This certification will be invalidated if you make any modifications to the child safety seat. Only the manufacturer is permitted to make modifications to the child safety seat. Unauthorised technical changes can cause the protective function of the seat to be reduced or completely eliminated. Do not make any technical changes to the child safety seat.

**DANGER!** Use the C007 i-Size exclusively for securing your child in your vehicle. It is in no way suitable for using as a seat or toy at home.

## USE IN THE VEHICLE

Please observe the instructions for using Enhanced Child Restraint Systems (ECRS) in the vehicle handbook. During using, be sure to observe any restrictions relating to airbags.

Please refer to the vehicle handbook information about vehicle seats which are certified for the use of children's restraining systems according to ECE R16.

Flex i-Size usage options:

C007 Child safety seat	Vehicle seating position with ISOFIX	
	i-Size	NOT i-Size
C007 i-Size	✓	✓

You can use your child safety seat as follows:

Facing forwards (in the direction of travel)	Yes ②③
Facing backwards (against the direction of travel)	Yes ①
With adult 2-point belt	No
With adult 3-point belt	Yes ③
On seats featuring: ISOFIX fastenings	Yes ①②③



40-105cm  
≤18kg



76-150cm

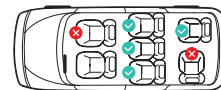

- ① When using as i-Size (40-105cm). This ECRS is suitable for vehicles which equipped with the ECE R14 requirements and installed ISOFIX, then can use it.
- ② When using as i-Size (76-105cm). This ECRS is suitable for vehicles which equipped with the ECE R14 requirements and installed ISOFIX, then can use it.
- ③ When using as i-Size booster seat (100-150cm). This ECRS is suitable for seat belt models equipped with the adult 3-point belts that has passed the ECE R16 requirement and is not suitable for models only equipped with adult 2-point belts.

(Please observe the applicable regulations in force in your country)

1. Facing backwards 40-105cm: Do not use on passenger seats with an active front airbag!
2. Facing forwards 76-150cm: If there is a passenger airbag: Slide the passenger seat well backwards and follow any relevant directions in your vehicle handbook, please ensure that the airbag is deactivated.

## INSTALLATION

### 1. ISOFIX

1.If your vehicle is not fitted with ISOFIX Insertion Aids as standard, clamp the two **ISOFIX Insertion Aids (1)**, which are included in the scope of delivery of the seat, with the opening pointing upwards, to the two **ISOFIX Fastening Points (2)** of your vehicle. If you don't have **ISOFIX Insertion Aids (1)**, please ignore this step.

---

**TIP!** The ISOFIX fastening points are located between the surface and the backrest of the vehicle seat.

---

2.Press the **ISOFIX Buttons (26)** to push out the two **ISOFIX Locking Arms (25)** from the seat base.

3.Push back the child safety seat until you hear a clicking sound then on both sides of the ISOFIX indicators turn into green safety color.

4.Move the child safety seat backwards to against the vehicle seat, to confirm the child safety seat is firmly against the vehicle seat.

---

**TIP!** Release button towards each other to loosen the ISOFIX fastening points on both sides. Move the ISOFIX locking arms back into the seat base, it can protect ISOFIX.

---

### 2. Top Tether

1.Pull out the top tether strap by pressing the **Top Tether Adjuster (23)** button.

2.Pull the top tether long enough to hang the **Top Tether Clip (24)** on the fixed point, which is on the back of the vehicle seat.

3.Make sure the top tether strap is tightened up and the **Top Tether Adjuster (23)** indicator turns into green.

### 3. Rotation

1.Pull the **360° Rotation Adjuster (11)** with finger, rotate the seat shell.

2.Rotate the seat shell so it is facing either forwards or backwards, depending on the height of your child, until it engages with a clicking sound.

---

**TIP!** When installed in forward facing position with ISOFIX and top tether (76-105 cm), function of rotation may be restricted.

---

---

**⚠ DANGER!** When the seat is rotated to 90°, the user can place the child in this position, but user can not use this angle during driving.

---

### 4. Seat Angle

The seat shell of the Flex i-Size can be used in 2 level position facing forwards and used in 4 level position facing backwards.

1.Pull the **Recline Handle (12)** and pull the seat outward, then the seat can be adjusted. It can be adjusted to 2 positions for facing forwards facing use.

Rotate the seat to the backwards direction, and the seat can be adjusted to fifth to eighth level.

40-87cm: Facing backwards installation, use fifth level to eighth level.

87-105cm: Facing backwards installation, use fifth level.

76-105cm: Facing forwards installation, use fourth level.

100-150cm: Facing forwards installation, use first level.

---

**TIP!** In 76-105cm, the ECRS may not fit in all vehicles varied in models, recline angles can not match vehicle seat when adjusting.

---

### 5. Using

1.Loosen the **Shoulder Straps (6)** by pressing the

**Adjustment Button (9)** and pull both **Shoulder Straps (6)** forwards, loosen it as much as possible.

2.Press **Red Release Button (18)** to open the **Harness Buckle (7)**. Place child in child safety seat.

3.Bring both **Buckle Tongues (17)**. Lock buckle tongues in **Harness Buckle (7)**, until they engage with a clicking sound.

4.Pull the **Headrest Height Adjuster (19)**, select the correct height of the **Headrest (3)** and engage it in position that fits your child by releasing the adjuster.

5.Adjust the **Headrest (3)** to proper position. Make sure the distance between child's shoulder and the bottom of the headrest is lower than one finger.

Pull the **Crotch Strap (10)** until the strap lies flat and snug on your child's body. Make sure that the shoulder straps slightly higher or equal to child's shoulders.

---

**⚠ WARNING!** Before each car journey, in order to ensure your child's safety, make sure that...

The child safety seat is fastened in the **ISOFIX Fastening Points** (2) on both sides with the **ISOFIX Locking Arms** (25) and both **ISOFIX Buttons** (26) are fully green;

The child safety seat is securely fastened;

The harness of the child safety seat is fitted snugly to the child's body without being constricting and should not be twisted;

The **Shoulder Straps** (6) are correctly adjusted and the straps are not twisted;

The **Shoulder Pads** (5) are in the correct position on your child's body;

The child safety seat is facing in the right direction for your child's age/size;

The **Buckle Tongues** (17) are inserted into the **Harness Buckle** (7).

---

**⚠ DANGER!** If your child tries to open the ISOFIX buttons or the red release button, stop immediately as soon as possible. Check whether the child safety seat is correctly fastened and ensure that your child is correctly secured. Explain to your child the dangers associated with their actions.

---

## 6. Store 5-point harness

Once the child reaches a height of 100cm, the 5-point safety harness should be stored away and the child should be secured with the adult safety-belt.

1. Open the **Harness Buckle** (7) as shown. Remove **Seat "Cradleyou" Reducer** (15) and **Crotch Pad** (8).

2. Loosen **Shoulder Straps** (6).

3. Open **Seat Cover** (4).

Re-connect the **Harness Buckle** (7). Hide **Shoulder Straps** (6) under the cover and hide the **Harness Buckle** (7) to the storage.

---

**⚠ WARNING!** Remove the seat "cradleyou" reducer accordingly when your baby is >87cm.

---

Reattach the 5-point harness: Follow the steps for (store 5-point harness) in reverse order.

## 7. Using The Child Safety Seat

### Facing backwards (40-105cm) Installation

Install the child safety seat with ISOFIX+Top Tether (refer to page 3 and 9).

Hang the **Top Tether Clip** (24) on the fixed point, which on the back of the vehicle seat, the position of the fixed point are shown in the picture (one of the A/B/C positions).

### Facing forwards (76-105cm) Installation

Install the child safety seat with ISOFIX+Top Tether (refer to page 3 and 9)

Hang the **Top Tether Clip** (24) on the fixed point, which on the back of the vehicle seat, the position of the fixed point are shown in the picture (one of the A/B/C positions).

---

**⚠ DANGER!** For the safety of your child, the top tether must be tightened up during driving.

---

### Facing forwards (100-150cm) Installation

Store 5-point harness (Refer to page 6 and 11).

Install the child safety seat with ISOFIX+adult safety-belt. (refer to page 3 and 9). If you don't have ISOFIX, please ignore this step. Install the child safety seat with adult safety-belt only.

Pull out the belt from the belt ALR (Automatic Locking Retractor). The shoulder belt through

the same side of **Belt Guidance** (14) on headrest, then pull the shoulder belt and lap belt together through the other **Belt Guidance** (16) on the seat base.

Lock the tip of the buckle into the vehicle seat buckle with a clicking sound. Follow the direction of arrow to tighten belt, and put redundant belt into ALR. Shake the child safety seat to make sure it is securely attached.

---

**ⓘ TIP!** Keep the shoulder belt at the position of belt guidance between the outside of the neck and shoulder (in the middle of point a and point b).

---

---

**⚠ WARNING!** The adult safety-belt must not be twisted or have their places changed over.

---

---

**ⓘ TIP!** The importance of ensuring that any lap belt is worn low down, so that the pelvis is firmly engaged, shall be stressed.

---

---

**ⓘ TIP!** The shoulder belt section must run diagonally backward. You can adjust the course of the belt with your vehicle's ALR on both sides.

---

## 8. Clean

### Shoulder Pads

Open the **Shoulder Pads** (5) and remove it from the shoulder pads connector.

### Seat cover

Only use authentic Flex **Seat Cover** (4). The **Seat Cover** (4) is an integral part of the child safety seat and is key to ensure the trouble-free functionality of the system. Replacement **Seat Cover** (4) are available from your dealer.

The **Shoulder Pads** (5), **Seat Cover** (4) and **Seat "Cradleyou" Reducer** (15) can be washed in luke-warm soapy water. Remove all foam parts from the top and bottom sections before washing. These must not be washed.

**TIP!** Use R-elf to assemble cover more easily.



### Harness Buckle

1. Open the **Harness Buckle** (7) as shown. Remove **Crotch Pad** (8).
2. Lift the seat cover, pull down **Harness Buckle** (7) across **Seat Cover** (4).
3. Rotate the metal plate on crotch straps from (F) by 90° vertically. Slide the metal plate through the harness slot in the way (E) lies in horizontal position, then **Harness Buckle** (7) can take out from slot (D).

To re-install **Harness Buckle** (7) follow the steps in reverse order, until the metal plate is hooked into the harness slot. Thread the **Harness Buckle** (7) through the **Crotch Pad** (8) on the cover. Make sure the metal plate under slot (F) when you are using.

**CAUTION!** Tug hard on the crotch strap to make sure that it is secure in the seat shell.

To ensure the safety of your child, it is absolutely essential that the **Harness Buckle** (7) continues to function correctly. **Harness Buckle** (7) malfunctions are usually caused by a build-up of soiling or by external objects:

When you press the **Red Release Button** (18), it takes a long time for the **Buckle Tongues** (17) to be ejected.

The **Buckle Tongues** (17) no longer engage (i.e. when you try to push them in, they pop out again).

The **Buckle Tongues** (17) engage without a clicking sound.

The **Buckle Tongues** (17) are difficult to push in (you feel a certain amount of resistance).

The **Buckle Tongues** (17) only opens if extreme force is applied.

Remedy: Soak the harness buckle in warm water containing washing-up liquid for at least an hour. Rinse the buckle thoroughly and dry it.

The plastic parts and the harnesses can be cleaned with soapy water. Do not use any caustic cleaning agents (such as solvents).

## DISPOSAL

Please observe the waste disposal regulations in your country.

Disposal of packaging	Container for cardboard boxes
Seat cover	Residual waste, waste incineration
Plastic parts	To be placed in the corresponding container according to labelling
Metal parts	Container for metals
Belt straps	Container for polyester
Buckle and tongue	Residual waste



## SAFETY NOTES

### NOTICE

Notice regarding i-Size category Enhanced Child Restraint Systems (40-105cm)

This is an i-Size Enhanced Child Restraint System. It is approved according to UN Regulation No. 129, for use in, i-Size compatible vehicle seating positions as indicated by vehicle manufacturers in the vehicle user's manual.

If in doubt, consult either the Enhanced Child Restraint System manufacturer or the retailer.

Notice regarding i-Size booster seat category Enhanced Child Restraint Systems (100-150cm)

This is an i-Size booster seat Enhanced Child Restraint System. It is approved according to UN Regulation No.129, for use primarily in "i-Size seating positions" as indicated by vehicle manufacturers in the vehicle user's manual.

If in doubt, consult either the Enhanced Child Restraint System manufacturer or the retailer.

### ⚠ DANGER!

Please carefully read and make sure you under

stand all instructions in this manual and in the vehicle handbook relate to child safety seats. Install and use the child safety seat as described in the instruction manual. Failure to do this could result in serious injury even death of your child. Keep the instructions together with the ECRS for future reference.

### ⚠ DANGER!

Because of potential medical issues inherent to low birth weight and premature infants, always have a trained professional doctor or hospital staff assess the suitability of the ECRS prior to leaving the hospital or using the ECRS.

MAKE SURE any straps holding the ECRS to the vehicle should be tight. Any straps restraining the child should be adjusted to the child's body. Make sure straps should not be twisted.

MAKE SURE in 100-150cm body size, the lap vehicle seat belt must be worn in such a way as to properly secure the pelvis of the child.

MAKE SURE the ECRS is changed when it has been

subject to violent stresses in an accident.

MAKE SURE the rigid items and plastic parts of a ECRS shall be so located and installed that they are not liable, during everyday use of the vehicle, to become trapped by a movable seat or in a door of the vehicle.

DO NOT make any alteration or additions to the ECRS without the approval of the Type Approval Authority, or a danger occurs if not following closely the installation instructions provided by the child restraint manufacturer.

HOT! The child seat should be kept away from sunlight if the seat is not provided with a textile cover, otherwise it may be too hot for the child's skin.

DO NOT leave your child unattended in this restraint even for a short time.

MAKE SURE any luggage or other objects liable to cause injuries in the event of a collision shall be properly secured.

A) DO NOT use the ECRS without the cover.  
B) DO NOT replace seat cover with any other than the one recommended by the manufacturer, because the cover constitutes an integral part of the restraint performance.

DO NOT use forward facing before the child's age exceeds 15 months (refer to instruction).

### ⚠ WARNING!

The safest place for your baby is the rear of your car.

However, if you need to install the seat in the front passenger seat, please ensure that the airbag is deactivated.