



Life is Precious. Be Safe.

Koopers Distribution Sdn Bhd

☎ 03-78324338

🌐 www.koopers.co

📘 www.facebook.com/koopersmalaysia

✉ sales@koopers.co

📍 18-1, Jalan Bulan U5/BM, Section U5, Bandar Pinggiran Subang,
40150 Shah Alam, Selangor
Malaysia



Life is Precious.
Be Safe.

Group



Applicable to

0 -18kg

0 - 4 years

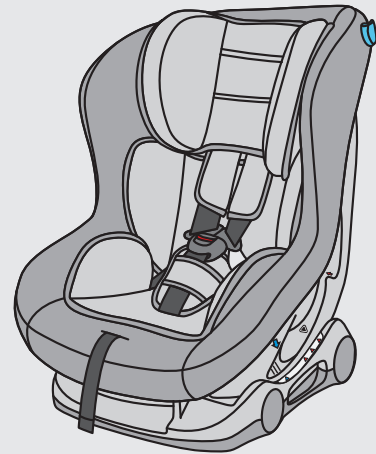

Contents

| | |
|---|------|
| 1. Parts and interior equipment..... | 3 |
| 2. Usage | |
| 2.1 Install position of the child seat in vehicle..... | 4 |
| 2.2 Checking the shoulder strap height..... | 4 |
| 2.3 Usage of buckle..... | 5 |
| 2.4 Adjust and use the harness..... | 5 |
| 2.5 Adjust the child seat to different incline positions..... | 6 |
| 2.6 Adjust the shoulder strap height..... | 6 |
| 2.7 Remove the crotch pad and buckle..... | 7 |
| 2.8 Use of the Lock-off..... | 7 |
| 3. Installation of the child seat..... | 7-10 |
| 4. Maintenance and cleaning..... | 10 |



Notice

1. This is a "Universal" child restraint, it is approved to Regulation NO.44.04 series of amendments, for general use in vehicles and it will fit most, but not all, car seats.
2. A correct fit is likely if the vehicle manufacturer has declared in the vehicle handbook that the vehicle is capable of accepting a "Universal" child restraint for this age group.
3. This child restraint has been classified as "Universal" under more stringent conditions than those which applied to earlier designs which do not carry this notice.
4. If in doubt, consult either the child restraint manufacturer or the retailer.

Only suitable if the vehicle is fitted with 3-point safety belts, Approved to UN/ECE Regulation No.16 or other equivalent standards.

Feature

1. This product is called Restraining devices for child occupants of power-driven vehicles, commonly known as the child seat. Product appearance streamlined bionic design, elegant appearance. Precision injection molding process, high strength, compact structure, solid. Cloth sets of flame retardance fabric, wear-resistant, soft, antibacterial, and there are a variety of colors.
2. The backrest of this product can be adjusted to 4 different incline positions, that is the child can sit or recline during the travel.
3. This product shoulder strap height with 3 adjustable shoulder strap height according to different height of the child.
4. This child seat can only be used for children 0-4 years old, installed rearward-facing or forward-facing.

Safety warning

For your child's safety, please read these instructions carefully before use and keep them for future reference. Failure to follow the instructions contained in this manual could result in serious injury to your child.

1. This child seat can only be used with the harness for children less than 18 kg in weight (group 0+, less than 13 kg; group 1, 9-18 kg).
2. This child seat can be installed rearward-facing and forward-facing using a three-point lap and diagonal seat belt. Important-Do not use forward-facing before the child's weight exceeds 9 kg.
3. This instruction manual can be retained in the special space of the child seat for its life period.
4. Do not use this child seat in the home. It has not been designed for home use and should only be used in your car.
5. It shall be recommended that children are not left in their child restraint system unattended.
6. Do not place rear-facing child seat on front seat with airbag. Death or serious injury can occur.
7. The child seat should be changed when it has been subject to violent stresses in an accident.
8. For the reason of safety, the child seat must be fixed inside the vehicle even if you do not put your child inside the child seat.
9. Always make sure that any straps holding the seat restraint to the vehicle shall be tight, any straps restraining the child should be adjusted to the child's body, and check that the straps shall not be twisted.
10. Ensuring that any lap straps is worn low down, so that the pelvis is firmly engaged, shall be stressed
11. Do not use any load bearing contact points other than those described in the instructions and marked in the child restraint.
12. Any luggage or other objects liable to cause injuries in the event of a collision shall be properly secured.
13. The rigid items and plastic parts of a child restraint must be so located and installed that they are not liable, during everyday use of the vehicle to become trapped by a moveable seat or in a door of the vehicle.
14. To prevent from the risk of fall, your child should always be fastened.
15. It is dangerous to make any alteration or additions to the device without the approval of the competent authority, and a danger of not following closely the installation instructions provided by the child restraint manufacturer.
16. This child seat is designed for children from birth up to 18 kg. Never overload the child seat more than one child or with other loads.
17. The child restraint must not be used without the cover.
18. The seat cover should not be replaced with any other than the one recommended by the manufacturer, because the cover constitutes an integral part of the restraint performance.
19. Before you adjust any movable or adjustable parts of your child seat, you must remove your baby from the child seat.
20. The child seat should be kept away from sunlight if the seat is not provided with a textile, otherwise it may be too hot for the child's skin.
21. Never use a second-hand product, as you can never be certain what has happened to it.

1. Parts and interior equipment

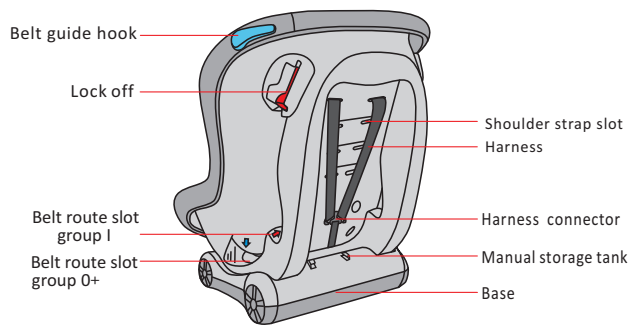
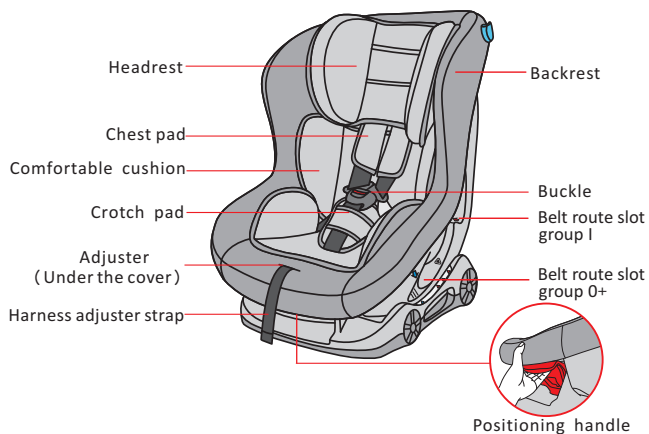

2. Usage

2.1 Install position of the child seat in vehicle



This child seat is suitable for conventional use in all cars equipped with 3 point seat belts that are fitted in accordance with European standard (ECE 44 or equivalent standard)

Important:

The child seat must only be installed using a lap and diagonal seat belt.

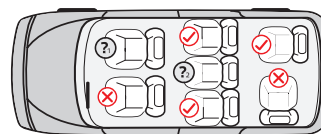

- ✓ Correct fitting/suitable
- ✗ Incorrect fitting/not suitable
- ? Not to be used on this seat if a passenger front airbag is active
- ? Only use on this seat if a lap and diagonal seat belt is fitted.

2.2 Checking the shoulder strap height

Always check that the shoulder straps are at the correct height for your child. The child's shoulders should always be thread through the slots in the cover and seat shell that are closest to the top of your child's shoulders.



2.3 Usage of buckle

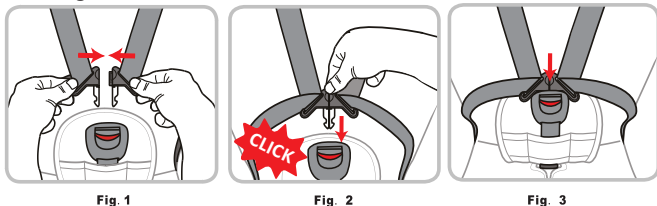

Firstly, adjust the shoulder straps height, please proceed as follows:

Step1. Put the two metal sections of the buckle connector together.

Step2. Slot the two buckle connectors into the slot in the buckle until they “click” place.

Step3. Check the harness is correctly locked by pulling the shoulder straps upwards.

To release the harness, you can press the red button of the buckle downwards, the two metal sections will be pop up.

2.4 Adjust and use the harness

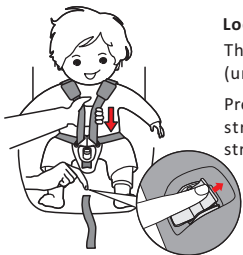

Loosen the harness

The harness is slackened by pressing the adjuster (under the adjuster cover) on the front of the seat.

Press down the adjuster as you grip the two shoulder straps with your another hand. Pull the shoulder straps towards you to loosen the harness.

Tighten the harness

Pull the shoulder straps upwards to remove the slack from the lap sections of the harness then pull the adjuster strap until the harness is fully tightened.

The harness should be adjusted as tightly as possible without causing discomfort to your child.

A loose harness can be dangerous. Check the harness adjuster and tighten each time the child is placed in the seat.



2.5 Adjust the child seat to different incline positions

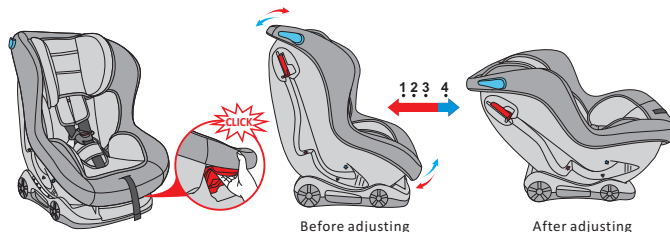

The child seat can be adjusted to 4 different positions. **If installed rearward-facing (group 0+), only the position 4 can be used.** Pull the positioning handle under the front of the seat upwards, and then pull or push the seat forwards or backwards. Release the positioning handle in the desired position and push until you hear a “click”.

Important: Check to make sure the child seat is securely locked in the desired position by pulling the positioning handle.

2.6 Adjust the shoulder strap height

If the height of your shoulder belts in child car seat is not fit for your child, adjust the height of the shoulder belt. Please proceed as follows:

Step 1. Loosen the shoulder harness (see point 2.4) turn the child seat to the back. Side the chest straps and shoulder straps off the harness connectors.

Step 2. Pull the straps through the shoulder strap slots from the front of the child seat. Now you can remove the shoulder straps and chest pad.

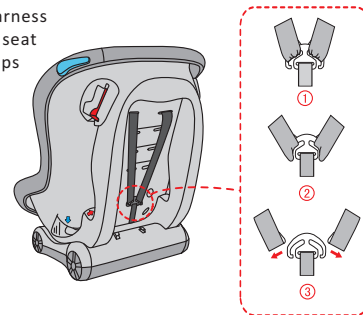

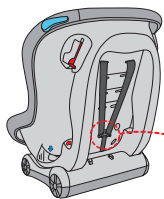

Step 3. Then re-thread the shoulder straps and chest straps into the appropriate strap slots from the front of the child seat and slide them onto the harness connectors.

Important: Make sure that both of the shoulder belts and chest belt go through slots at the same height, and not twisted.

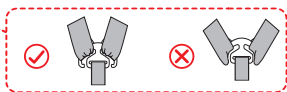

2.7 Remove the crotch pad and buckle

Adjust the child seat to position 4 and turn it to the bottom. Turn the harness locking clip on their narrowest end and thread it through the slot under the bottom of the child seat. So the crotch pad and buckle as well as harness straps can be removed.

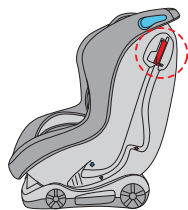
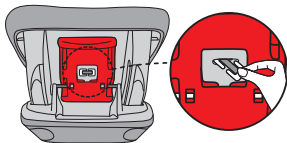

2.8 Use of the belt lock-off

Open the red belt lock-off, pull the diagonal belt into the belt red lock-off and then lock it.



Fig.1



Fig.2



Fig.3

3. Installation of the child seat

3.1 Installing the safety group 0+

This child seat can be used with the harness for children less than 13 kg in weight (group 0+), installed rearward facing using a three-point lap and diagonal seat belt.

Step 1: Adjust the child seat to position 4. Place the child seat on the car seat rearward-facing and make sure that the front of the child seat is firmly pressed against the car seat backrest.

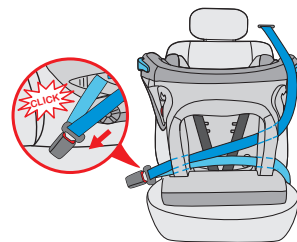
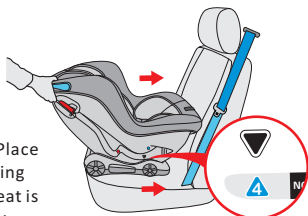

Step 2: Pull out the diagonal belt together with lap belt, through the belt route slot of backrest and then insert into car seat belt buckle, hear "click".

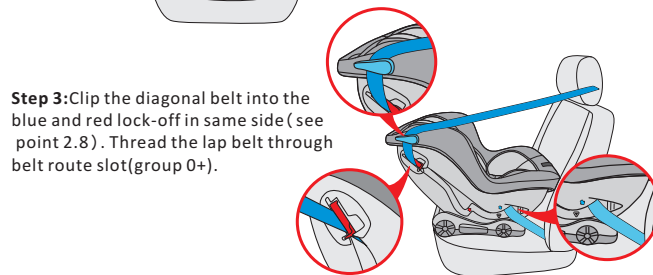

Step 3: Clip the diagonal belt into the blue and red lock-off in same side (see point 2.8). Thread the lap belt through belt route slot (group 0+).

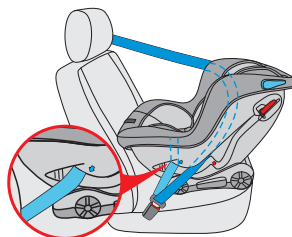

Step 4: Thread the lap belt through belt route slot (group 0+) of other side.

Step 5: Pull car seat belt follow the direction of red arrow and make sure the belt is tight enough. Then put the child into the seat and fasten the harness. Check that the harness does not twisted.

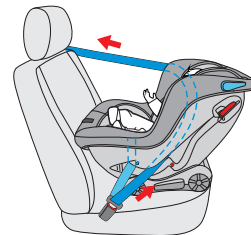

3.2 Installing the safety group I

This child seat can be used with the harness for children 9 kg to 18 kg in weight (group I), installed forward-facing using a three-point lap and diagonal seat belt.

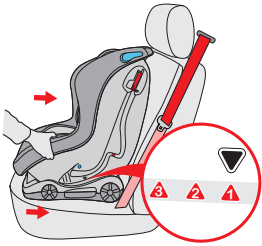

Step 1: Adjust the seat to the right position, place it on the car seat forward-facing and make sure the backrest of seat is firmly pressed against the backrest of car seat.

Step 2: Pull out the diagonal belt together with lap belt, through the belt route slot of backrest and then insert into car seat belt buckle, hear "click".

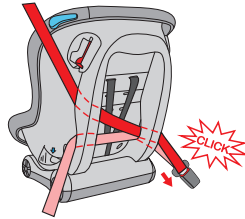

Step 3: Clip the diagonal belt into the red lock-off (see point 2.8). Thread the lap belt through belt route slot (group I).

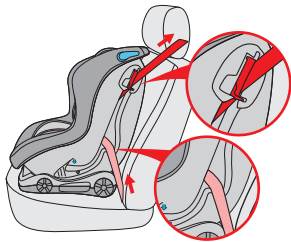

Step 4: Thread the lap belt through belt route slot (group I) of other side. Pull car seat belt follow the direction of red arrow and make sure the belt is tight enough.

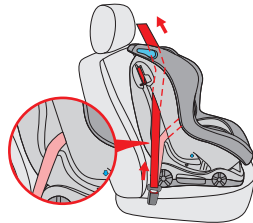

Step 5: Put the child into the seat and fasten the harness. Check that the harness does not twisted.

NOTICE: Recline positions (1, 2, 3) is only suitable for forward-facing installation. It can be adjusted before or after installation.

4. Maintenance and cleaning

4.1 Daily maintenance

1. In daily use, check periodically the child seat. The child seat should be replaced after an accident.
2. Please keep this child seat in dry and ventilated place to avoid damp moldy.
3. If the child seat becomes dusty, clean the seat belt and the plastic pieces by swiping them with a damp sponge and let it dry under ambience.
4. If food or drink drop accidentally on the buckle, disassemble the seat belt from the child seat and rinse it gently by warm water. Leave it dry under ambience.
5. For cleaning the entire child seat fabric cover, please refer to the 4.2 washing instruction.

4.2 Washing instruction

Never use any solvent, chemical detergent or lubricant on any part of your child seat.



Hand wash,
water
temperature
below 30°C



Do not bleach



Dry clean, any
solvent except
trichloroethylene



Do not tumble dry



Do not iron

4.3 Remove and assemble the fabric cover

1. Firstly, remove the crotch pad and buckle of the child seat (see page 7, 2.7), and then remove the shoulder straps and comfortable cushion.
2. Remove the fabric cover of the child seat. To install the fabric cover, please operate follow the above instructions in reverse order.