



køpers

Life is Precious. Be Safe.

Koopers Distribution Sdn Bhd

☎ 03-78324338

🌐 www.koopers.co

📘 www.facebook.com/koopersmalaysia

✉ sales@koopers.co

📍 18-1, Jalan Bulan U5/BM, Section U5, Bandar Pinggiran Subang,
40150 Shah Alam, Selangor
Malaysia



Life is Precious.
Be Safe.

LEVI

GROUP I, II, III

9 - 36kg (9 months - 12 years)

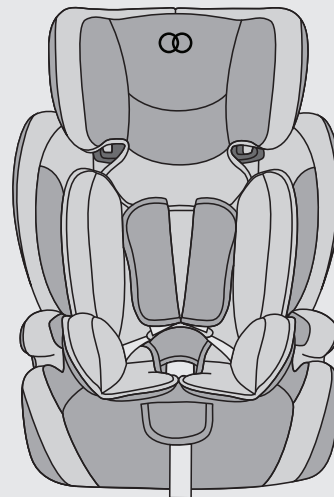

Instruction Manual

Contents

1. Vital information-READ NOW.....	2-3
2.Safety instruction.....	4
3.Using safety seat in this way.....	4
4.Parts and interior equipment.....	5
5.Scope of application for children.....	6
6.How to place the safety seat.....	6
7.Installing the safety group I	
7.1 Installing the safety car seat.....	7-9
7.2 Securing the child in the safety car seat.....	10-12
8.Installing the safety group II,III	
8.1 Remove the buckle and car seat pad.....	12-14
8.2 Installing the safety car seat.....	15-16
9.Remove the cover.....	17-20
10.Steps of backrest and base assembly.....	21
11.Maintenance and cleaning	
11.1 Daily maintenance.....	22
11.2 Washing instruction.....	22
11.3 Remove and assemble the fabric cover.....	22

Notice

1. This is a "Universal" child restraint, it is approved to Regulation NO.44,04 series of amendments, for general use in vehicles and it will fit most, but not all, car seats.
2. A correct fit is likely if the vehicle manufacturer has declared in the vehicle handbook that the vehicle is capable of accepting a "Universal" child restraint for this age group.
3. This child restraint has been classified as "Universal" under more stringent conditions than those which applied to earlier designs which do not carry this notice.
4. If in doubt, consult either the child restraint manufacturer or the retailer.

Only suitable if the vehicle is fitted with 3-point safety belts, Approved to UN/ECE Regulation No.16 or other equivalent standards.

1. Vital information-READ NOW

For your child's safety, please read these instructions carefully before use and keep them for future reference. Failure to follow the instructions contained in this manual could result in serious injury to your child.

1. This child safety seat can only be used with the harness for children 9kg to 18kg in weight (group I: 9 - 18kg ; group II, III: 15-36 kg).
2. This instruction manual can be retained in the special space of the child seat for its life period.
3. Do not use this child safety seat at the home. It has not been designed for home use and should only be used in your car.
4. Never leave your child unattended in the child restraint system even for a short time.
5. The child safety seat should be changed when it has been subject to violent stresses in an accident.
6. This child restraint should be securely belted in the vehicle even when not in use. In a crash or sudden stop, an unsecured child safety seat may injure other occupants.

7. Always make sure that any straps holding the seat restraint to the vehicle shall be tight, any straps restraining the child should be adjusted to the child's body, and check that the straps shall not be twisted.

8. **IMPORTANT!** Ensuring that any lap straps is worn low down, so that the pelvis is firmly engaged.

9. Do not use any load bearing contact points other than those described in the instructions and marked in the child restraint, when in doubt, please contact the child restraint manufacturer.

10. Any luggage or other objects liable to cause injuries in the event of a collision shall be properly secured.

11. The rigid items and plastic parts of a child restraint must be so located and installed that they are not liable, during everyday use of the vehicle to become trapped by a moveable seat or in a door of the vehicle.

12. To prevent from the risk of fall, your child should always be fastened.

13. It is dangerous to make any alteration or additions to the device without the approval of the competent authority, and a danger of not following closely the installation instructions provided by the child restraint manufacturer.

14. This child safety seat is designed for children from 9 to 36 kg. Never overload the child safety seat more than one child or with other loads.

15. The child restraint must not be used without the cover.

16. The seat cover should not be replaced with any other than the one recommended by the manufacturer, because the cover constitutes an integral part of the restraint performance.

17. Before you adjust any movable or adjustable parts of your child safety seat, you must remove your baby from the child safety seat.

18. The child safety seat should be kept away from sunlight if the seat is not provided with a textile, otherwise it may be too hot for the child's skin.

19. Never use a second-hand product, as you can never be certain what was happened to it.

20. **Notice:** Do not use in any configuration not shown in the instructions.

2. Safety instruction

Only suitable if the approved vehicles are fitted with 3 point safety-belts, approved to UN/ECE Regulation No.16 or other equivalent standards.

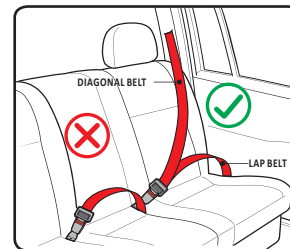

3. Using safety seat in this way

Forward facing traffic direction	Correct
Back facing traffic direction	Error
Vehicle is only fitted with 2-point safety belt	Error
Vehicle is fitted with 3-point safety belt	Correct
Seat beside the driver	Correct
Rear seat	Correct
Rear middle seats Three-point Belt	Correct

3.1 Please carefully implement the Country Traffic Safety Regulations

- Do not install the child safety seat at the front seat with airbag.
- Please read the instruction manual carefully that how to use the airbag.

NOTICE

- ✔ You can install this position
- ✘ Unable to install the position
- ? Do not install the child safety seat at the front seat with air bag.
- ? Only with the three point safety belt, can this location.

4. Parts and interior equipment

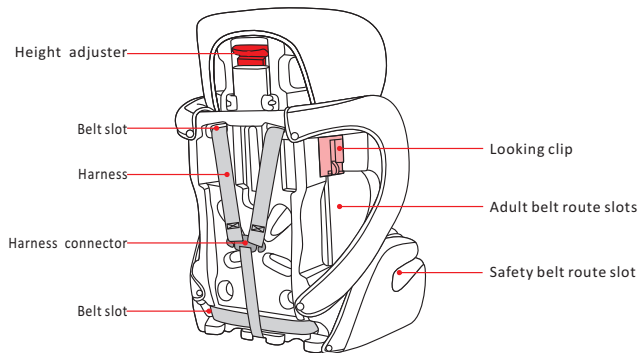
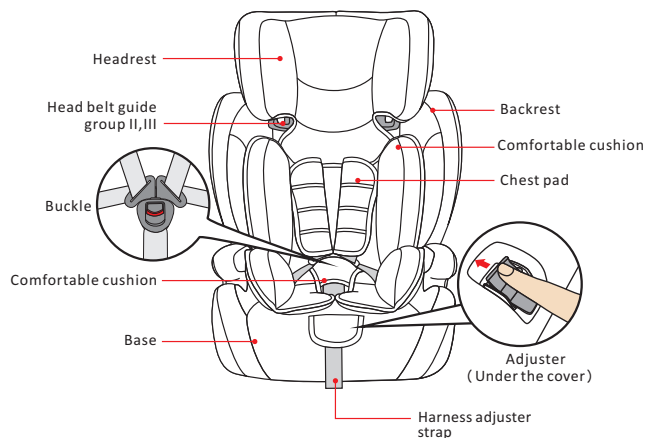

5. Scope of application for children

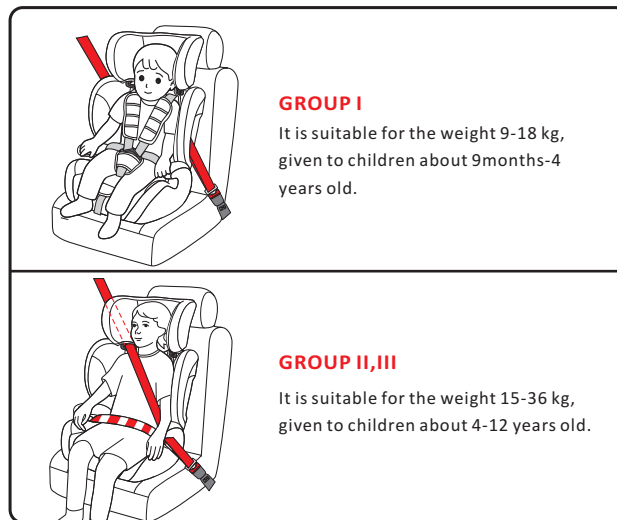

6. How to place the safety seat

⚠ Note: In order to keep safety, please put the restraint system on the back seat, and ensure that the backrest and the car seat nicely.

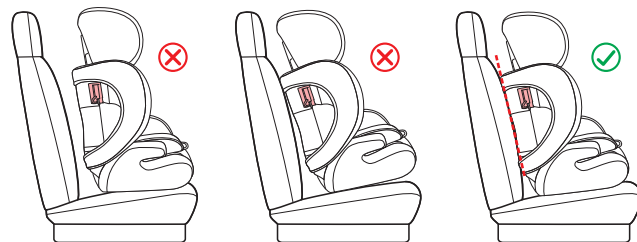

7. Installing the safety group I

It is suitable for the weight 9-18 kg, given to children about 9 months-4 years old.

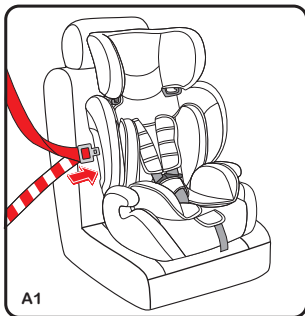

7.1 Installing the safety car seat

Step 1: Place the child safety seat on the vehicles ' seat .Pull out the diagonal belt together with lap belt, through the belt route slot of backrest(A1、 A2) .

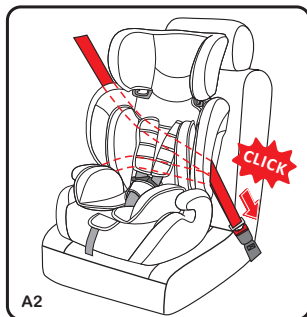

Step 2: Insert into car seat belt buckle Hear a "CLICK".

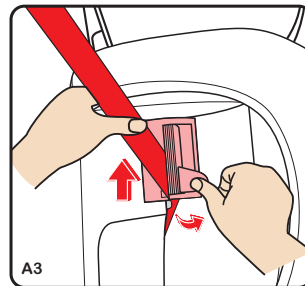

Step 3: Clip the diagonal belt into the locking clip.(A3、 A4) .

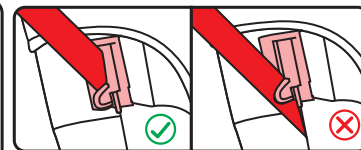
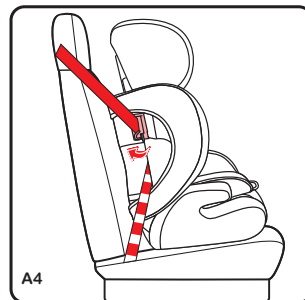

▲ Note! Please refer to the following picture, clip the safety belt into the locking clip in the right way(A5)

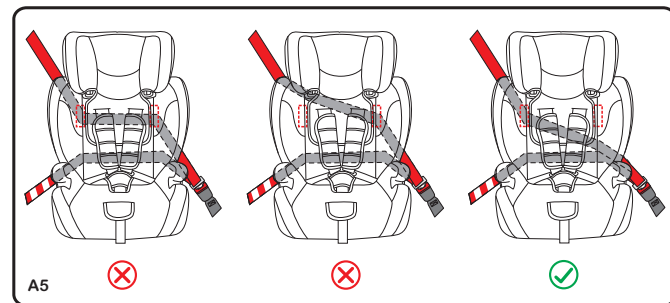

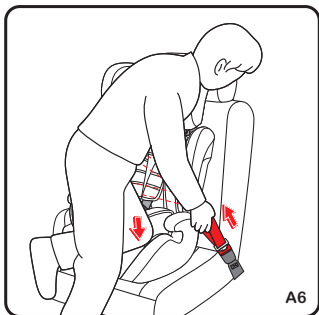

Step 4: Pull car seat belt follow the direction of red arrow and make sure the belt is tight enough(A6、 A7).

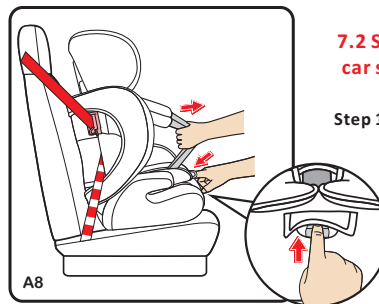
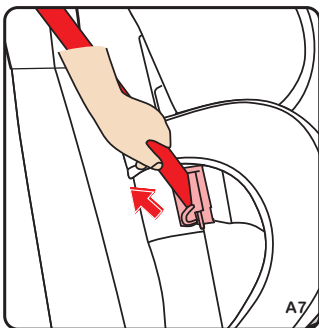

7.2 Securing the child in the safety car seat.

Step 1. Loosen the harness

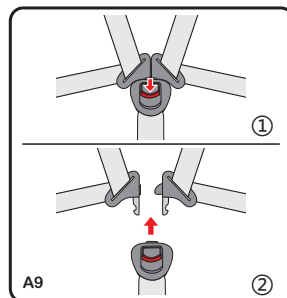

Step 2: Release the buckle



Step 3: Put the child into the safety car seat.

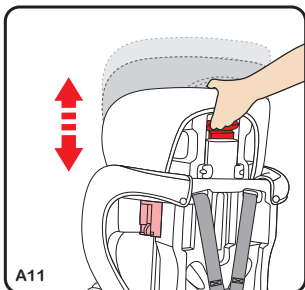

Step 4: Pull the height adjuster to adjust the height of the harness and the headrest according to the child's height(A11).

⚠ Note! The height for the harness is adjusted by lifting the headrest(A12).

A11

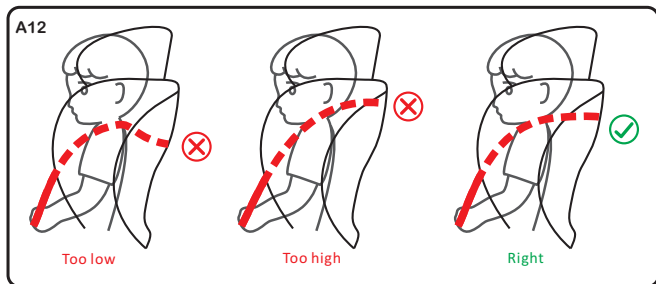

A12

Too low

Too high

Right

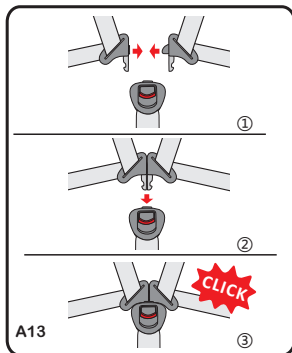

A13

Step 5. Align the left and right buckle tongues to one tongue and insert into the buckle until you hear a "Click".



A14

Step 6: Pull the shoulder straps upwards to remove the slack from the lap sections of the harness then pull the adjuster strap until the harness is fully tightened.

8. Installing the safety group II,III

It is suitable for the weight 15-36 kg, for children about 4-12 years old Approx.

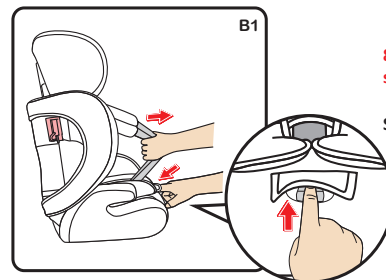

B1

8.1 Remove the buckle and car seat pad.

Step 1. Loosen the harness

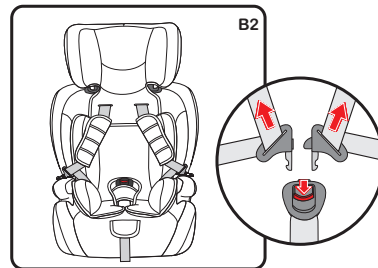

B2

Step 2: Release the buckle

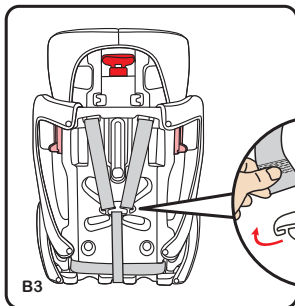

Step 3: Slide both of the harness straps off the harness connector.

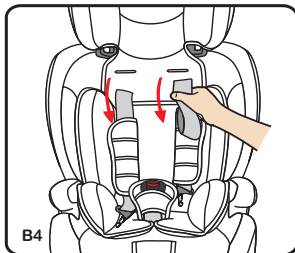

Step 4: Pull out the shoulder belt.

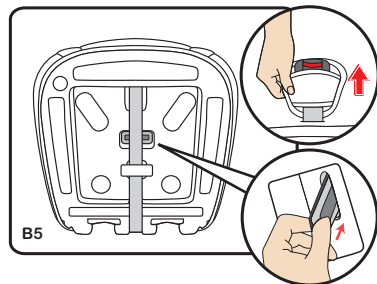

Step 5: Pull out the harness from the slot which under the safety car seat.

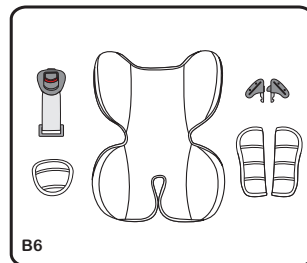

Step 6: Keep the removed cushion and accessories well.

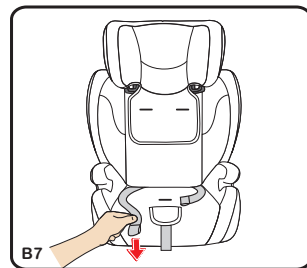

Step 7: Remove the shoulder straps from the safety car seat (B7, B8).

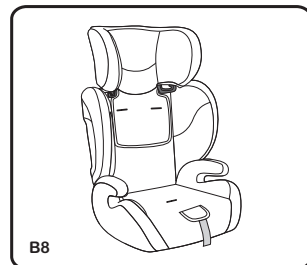

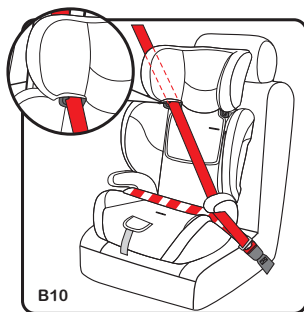
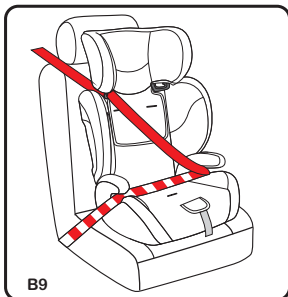

8.2 Installing the safety car seat

Step 1: Let the lap belt go through under the armrest (B9、 B10).

Step 2: The diagonal belt go through the belt guide on the side of the headrest (B10).

Step 3: Insert into car seat belt buckle Hear a “CLICK” (B11).



Belt goes wrong and hand is caught

hand is caught

The belt buckle is too high

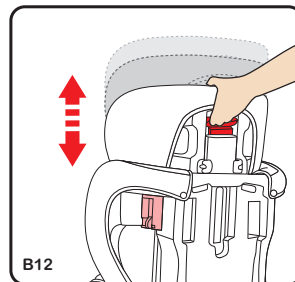

Step 4: Use the height adjuster to adjust the height of the headrest according to the child's height. The gap between head belt guide and baby is 2 finger width. The harness straps should be level with or just above the child's shoulders (B12、 B13).

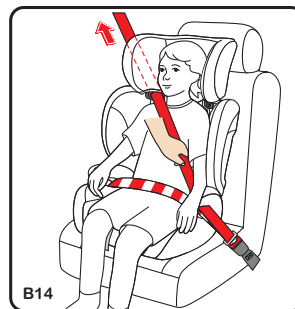

Step 5: Fasten car seat belt and make sure, it is tight enough.

Important: Ensuring that any lap straps is worn low down, so that the pelvis is firmly engaged, shall be stressed.

9. Remove the cover

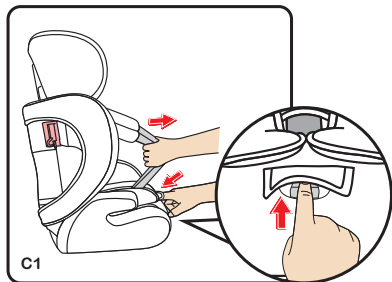

Step 1: Loosen the harness

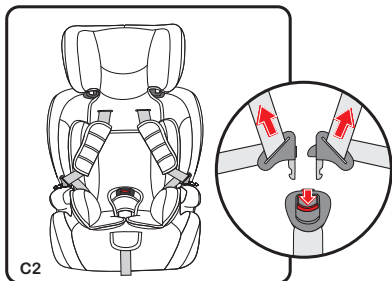

Step 2: Release the buckle

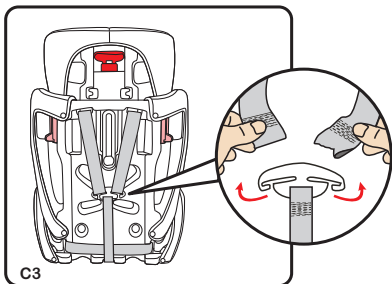

Step 3: Slide both of the harness straps off the harness connector.

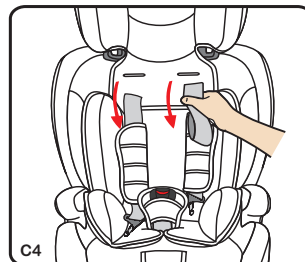

Step 4: Pull out the shoulder belt forward.

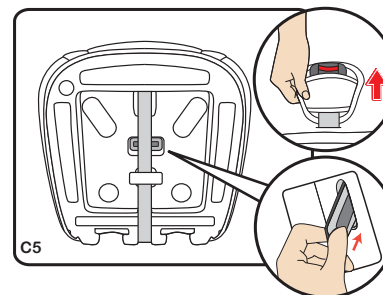

Step 5: Pull out the harness from the slot which is under the safety car seat.

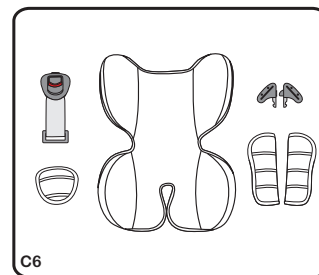

Step 6: Keep the removed cushion and accessories well.

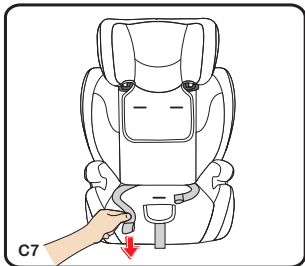

Step 7: Remove the shoulder straps from the safety car seat (C7、 C8).

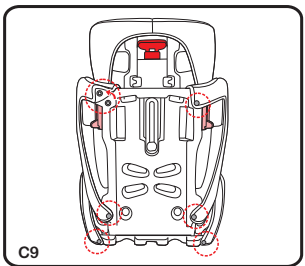
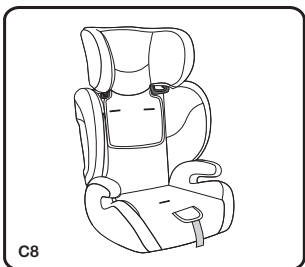

Step 8: Turn the seat to the back and unlock the snap fastener.

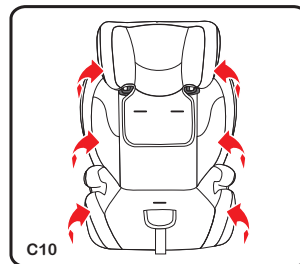

Step 9: Pull all directions to take out the cover (C10、 C11).

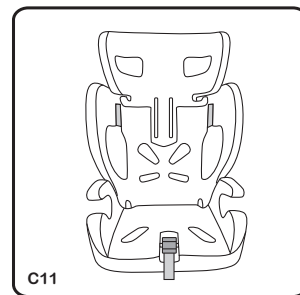

※ Follow in reverse order and repeat the procedure to put on the fabric cover

10. Steps of backrest and base assembly

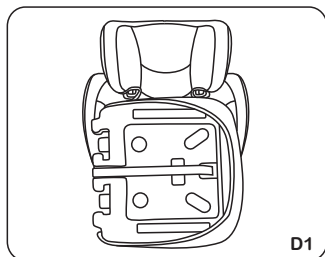

Step 1: Slide seat out of box

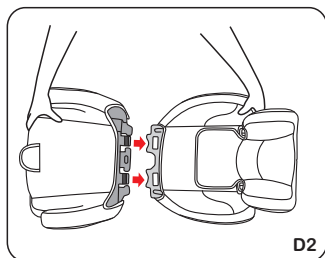

Step 2: Align base and backrest in a straight line.

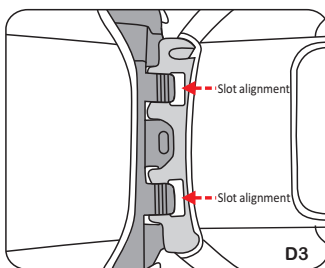

Step 3: Place backrest hooks inside base securely.

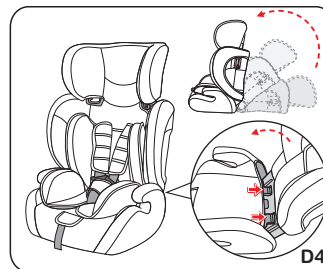

Step 4: Gently keep pressure on hooks as you lift backrest up.

WARNING: DO NOT FORCE MAY CAUSE DAMAGE.

11. Maintenance and cleaning

11.1 Daily maintenance

1. In daily use, check periodically the child seat. The child seat should be replaced after an accident.
2. Please keep this child seat in dry and ventilated place to avoid damp moldy.
3. If the child seat becomes dusty, clean the seat belt and the plastic pieces by swiping them with a damp sponge and let it dry naturally.
4. If food or drink drop accidentally on the buckle, disassemble the seat belt from the child seat and rinse it gently by warm water. Leave it dry naturally.
5. For cleaning the entire child seat fabric cover, please refer to the 11.2 washing instructions.

11.2 Washing instruction

Never use any solvent, chemical detergent or lubricant on any part of your child seat.



Hand wash,
water
temperature
below 30°C



Do not bleach



Dryclean, any
solvent except
trichloroethylene



Do not tumble dry



Do not iron

11.3 Remove and assemble the fabric cover

1. Firstly, remove the crotch pad and buckle of the child seat (see part 9), and then remove the shoulder straps and comfortable cushion.
2. Remove the fabric cover of the child seat. To install the fabric cover, please operate follow the above instructions in reverse order.